

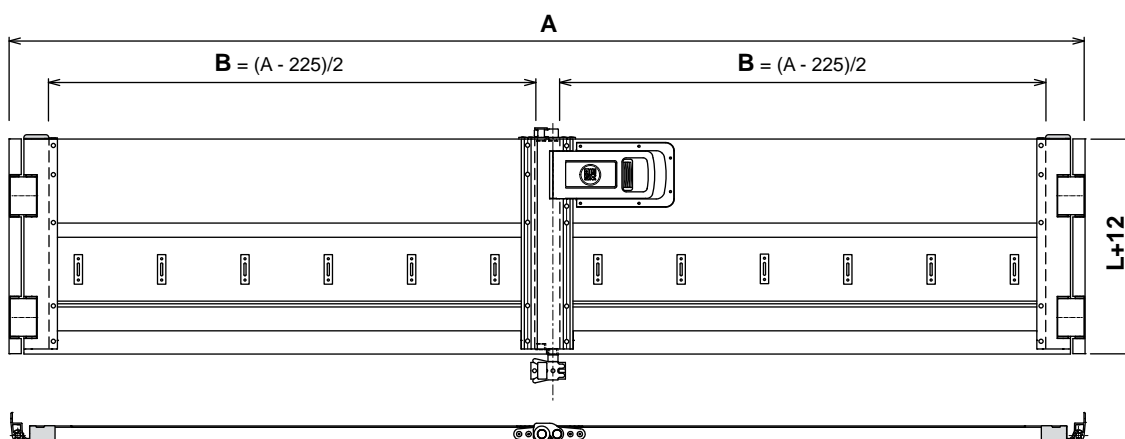

Drzwiczki tylne



DRZWICZKI TYLNE Z ZAMKNIĘCIEM WPUSZCZANYM



DRZWICZKI TYLNE Z ZAMKNIĘCIEM MOCOWANYM DO OBRZEŻA

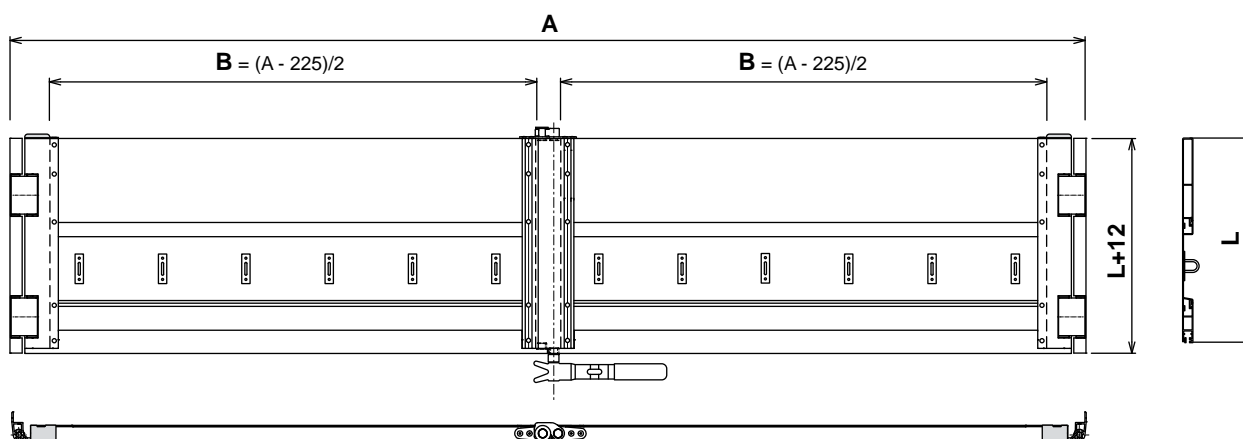

- A Szerokość zewnętrzna zabudowy
- B Długość profili wypełnienia
- C Wysokość drzwiczek tylnych

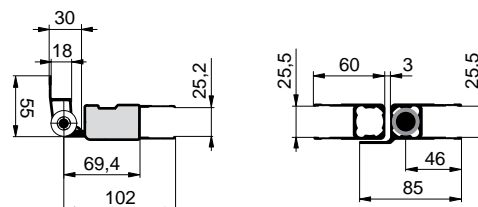

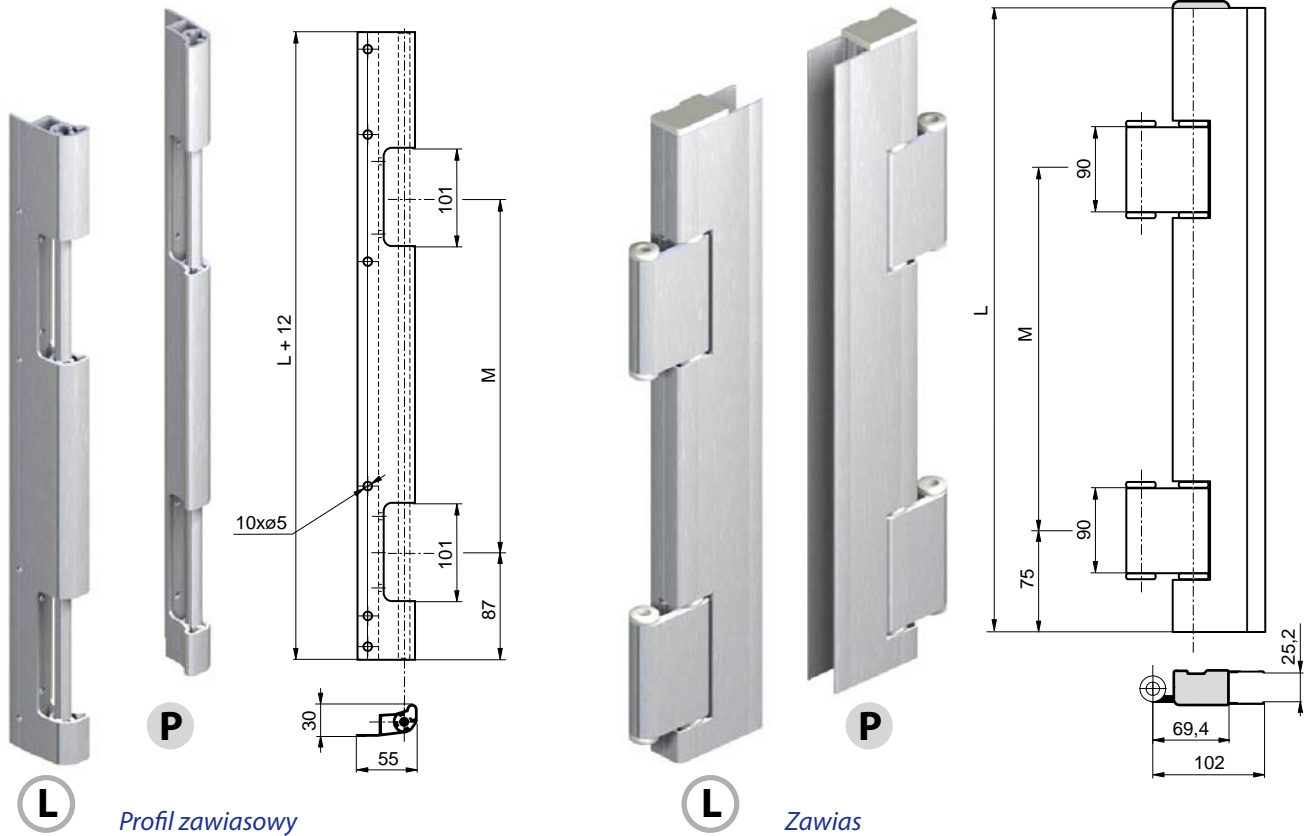
ZAWIASY DRZWICZEK TYLNYCH

Profil zawiasowy

Zawias

Zawias drzwiczek tylnych

Nr katalogowy	L [mm]	M [mm]	Typ powierzchni	Strona	Waga[kg]
731210400L	400	290	anoda	L	1,56
731210400P	400	290	anoda	P	1,56
731210500L	500	290	anoda	L	1,56
731210500P	500	290	anoda	P	1,56
731210600L	600	390	anoda	L	1,90
731210600P	600	390	anoda	P	1,90
731210800L	800	590	anoda	L	2,50
731210800P	800	590	anoda	P	2,50

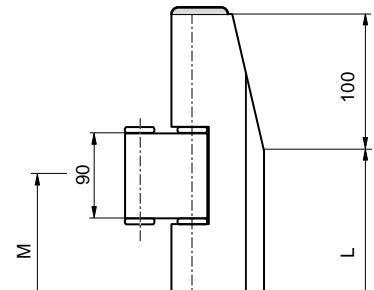

731210400L

Profil zawiasowy drzwiczek tylnych

Nr katalogowy	L [mm]	M [mm]	Typ powierzchni	Strona	Waga[kg]
731210401L	500	290	anoda	L	0,425
731210401P	500	290	anoda	P	0,425
731210501L	500	290	anoda	L	0,425
731210501P	500	290	anoda	P	0,425
731210601L	600	390	anoda	L	0,540
731210601P	600	390	anoda	P	0,540
731210801L	800	590	anoda	L	0,740
731210801P	800	590	anoda	P	0,740



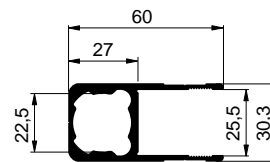
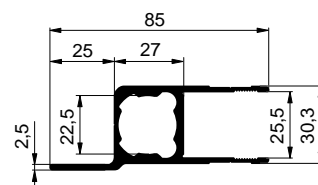
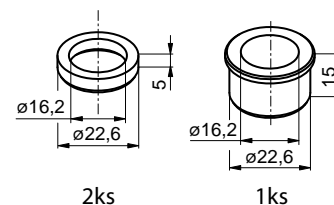

Nr katalogowy	Nazwa	Materiał	Waga [kg]
2506100214	Zamknięcie drzwiczek 888.16	nierdz.	1,800
42344510AY	Drążek zamknięcia ø16, 1400mm	ocynk	2,000
2212621267	Profil zakończeniowy A, tylne drzwiczki	anoda	1,319
2212621268	Profil zakończeniowy h, tylne drzwiczki	anoda	1,551
62VPS16224	Zestaw nasadek do tylnych drzwiczek	plastik	0,010
2506093900	Hak zamknięcia 788.2	ocynk	0,13
BND3312510	Rygiel dolny zamka drzwi ø16	ocynk	2,750
BND3310810	Uchwyt dolny zamka drzwi ø16	ocynk	1,118
BND3312210	Rygiel górny zamka drzwi ø16	ocynk	0,220
BND3310110	Uchwyt górny zamka drzwi ø16	ocynk	0,378

**2506100214****2212621267 - anoda****h2212621268 - anoda****BND3310110****BND3310810**

2ks

1ks

62VPS16224

2506002500

2506093900

2506002500

2506093900

BND3312510

6162013001

BND3312210

USZCZELKA DRZWICZEK TYLNYCH

62VT101228

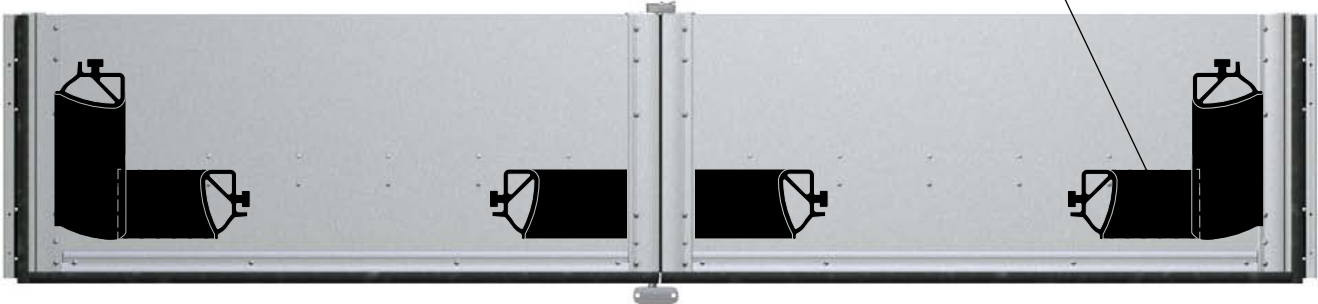

Widok od strony wewnętrznej



62VT101228

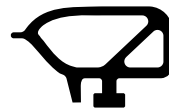

62VT101228



Szczegół zawiasu

Zabezpieczenie końca uszczelki



Widok od strony zewnętrznej